

DC-CT-1000I-S45DA

Compact and Low Power 300 ppm 1000 A Current Transducer

The DC-CT-1000I-S45DA is a compact and accurate 1000 A closed-loop current transducer based on ISOTEL's DC-CT® proprietary technology and the patented **Platiše Flux Sensor (PFS)**.

It features a standard DSUB interface with a 45 mm opening in an aluminium chassis, delivering 0.5 MHz of flat bandwidth with a total error below 300 ppm FS. It offers low standby power consumption of 0.7 W, a flexible unipolar/bipolar power supply, and differential current output.

Key Specifications

- Round opening 45 mm diameter
- Rated primary current $I_P = 1000 A_{DC}, 700 A_{AC}$
- Total Accuracy at Room Temperature <300 ppm, Overall Temperature Range <500 ppm
- Bandwidth >0.5 MHz @ -0.5 dB
- Immunity TBD RTI at 5 mT in any direction
- CMRR <140 dB @ 100 kHz
- TEDS (Current Loop Output Sensors Template)
- Range OK signal
- Power supply: unipolar 30 V or bipolar $\pm 15 V$ with floating current output
- Standby power consumption 0.7 W
- Typical power consumption 6.6 W at rated I_P
- Withstands rated DC/AC primary currents without being powered
- Operational range -40 to 85 °C

Applications

- Test and measuring equipment
- DC and AC metering
- Power quality analysis in mains
- Stable precision power supplies
- Battery Management Systems
- Electrical vehicle

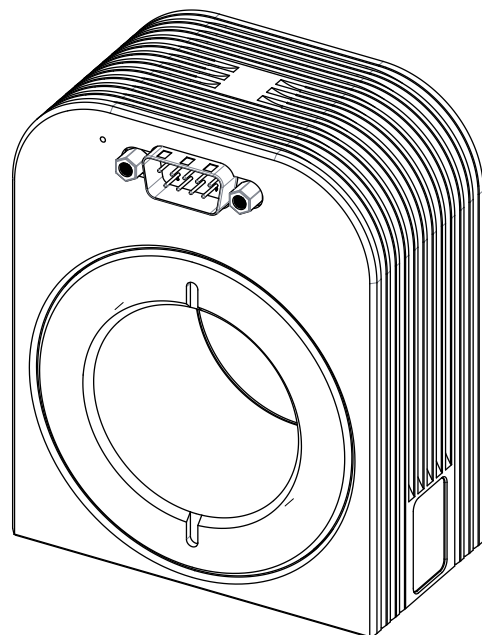
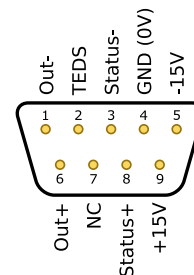

1 Electrical Characteristics

Description	Symbol	Min -5σ	Typ μ	Max 5σ	Unit	Fig
DC Accuracy						
Rated/Nominal Measuring Current DC	I_P	-1000	..	+1000	A	
Rated/Nominal Measuring Current AC RMS	$I_{P(AC)}$..	700	A	
Max Measuring Current Range AC RMS @ $T_a = 23^\circ\text{C}$	I_{Pmax}	-1000	..	+1000	A	
Max Overloading Current (limited by primary conductor)	I_{POV}		5		kA	
Nominal Secondary Current at I_P	I_S	-595.238	..	+595.238	mA	
Nominal Burden Resistance		0	1	3	Ω	23
Transformer Ratio	N		1680		turns	
Gain Error, BFSL over I_P @ $T_a = 23^\circ\text{C}$	ϵ_G		46	< 246	ppm	1..4
... @ $T_a = -40^\circ\text{C}$			79	< 127	ppm	
... @ $T_a = 85^\circ\text{C}$			120	< 351	ppm	
Gain Off-Center Error Up/Down (40 mm round bar)			150	< 250	ppm	
... Left/Right			50	< 100	ppm	
Integral Non-Linearity including Hysteresis @ $T_a = 23^\circ\text{C}$	ϵ_L		52	< 114	$\mu\text{A}/A_{range}$	1..4
... $T_a = -40^\circ\text{C}$			83	< 187	$\mu\text{A}/A_{range}$	5
... $T_a = 85^\circ\text{C}$			38	< 117	$\mu\text{A}/A_{range}$	6
Startup, Finder, Degauss, Offset RTI @ $I_P = 0\text{ A}$, $T_a = 23^\circ\text{C}$	I_{OS}		4.1	< 25	mA	
... $T_a = -40^\circ\text{C}$			3.5	< 25	mA	
... $T_a = 85^\circ\text{C}$			11.4	< 55	mA	
Long Term Stability at $I_P = 500\text{ A}$ including self-heating				< 15	mA	14,15
AC Accuracy						
Gain Accuracy @ 50/60 Hz, $I_P = 35\text{ A}_{RMS}$			500		ppm	11
... $I_P = 710\text{ A}_{RMS}$			100		ppm	11
Frequency Bandwidth @ -0.5 dB, $I_P = 0.7\text{ A}_{RMS}$	$f_{-0.5dB}$		> 0.5		MHz	
AC Flatness < 100 kHz			< 0.1		dB	10
... < 1 MHz			< 1		dB	10
Phase Shift < 100 kHz			< 2°		deg	
... < 1 MHz			< 5°		deg	
Typical RMS Noise at 10 kHz and entire T_A		0.6	0.7	≈ 1.4	mA	16
... 100 kHz and entire T_A		1.0	1.0	≈ 1.8	mA	17

Description	Symbol	Min -5σ	Typ μ	Max 5σ	Unit	Fig
... 1 MHz and entire T_A		7.1	7.7	≈ 8.2	mA	18
Platiše Flux Sensor Frequency (seen as ripple)	f_{PFS}		220		kHz	18..21
D-Class Switching Frequency (seen as ripple)	f_{DClass}		750		kHz	18..21

Signal Integrity

Time to Out of Range Detection to Status Deasserted			300		μ s	
Power-up Time to Status Asserted			1010	< 1100	ms	24
Primary to Secondary Maximum Difference RTI	I_{MD}		± 1500		mA	
Status Open Collector Max Current			25	50	mA	
Status Open Collector Max Voltage		-5	60	80	V	

Immunity

Common Mode Rejection @ 100 kHz RTI			0.08		μ A/V	
Immunity to external magnetic field, 5 mT in any direction RTI	I_{XB}		TBD	TBD	mA	

Noise Injection into Primary

Induced RMS voltage on primary conductor at $I_P = 0$			TBD		μ V	
Induced RMS voltage on primary conductor during Search			TBD		μ V	

Power Supply

Power Supply Voltage between pin 9 and 5		24	30	35	V	
Power Supply Maximum In-rush/working current @ 30 V				< 0.5	A	24
500 A Range Power Supply Voltage		12	30	35	V	
Standby (Idle) Power Consumption			0.7		W	
Power Consumption at $I_P = 500$ A and Burden 3Ω				3	W	
... at $I_P = 1000$ A and Burden 1Ω			6.6	8	W	
... at $I_P = 1000$ A and Burden 3Ω			7.6	9	W	

Environmental Conditions

Isolation CAT II / CAT III non-insulated wire			1000 / 600		V	
Isolation CAT II / CAT III insulated wire			1000		V	
Clearance / Creepage			12		mm	
Weight	m			650	g	
Storage and Operating Temperature	T_A	-40		+85	$^{\circ}$ C	

1.1 Accuracy

1.1.1 Non-Linearity including Offset due to Hysteresis

The following typical characteristics were obtained at a nominal power supply of ± 15 V, with a burden resistor of 2.5Ω , a 5 m cable length between the DC-CT and the burden resistor, Keithley DMM7510 and Keysight 34465A digital multimeters, a Danisense DR5000IM reference current sensor, an ambient temperature T_A of $23 \pm 5 \text{ }^\circ\text{C}$, a primary conductor consisting of a 20 mm diameter round bar in the central position, and a total system measurement uncertainty of 21 mA at 1000 A. Before each measurement, DC-CT-1000I was restarted. In the following plots, the error limit is derived as the sum of bias errors and expanded uncertainty $k = 5$:

$$E_{\text{total}} = I_{\text{meas}} \cdot \varepsilon_G + I_{\text{range}} \cdot \varepsilon_L + I_{OS} + 5u_c$$

where I_{meas} is the measured current, I_{range} is selected measurement range, and u_c is the combined standard uncertainty:

$$u_c = \sqrt{(I_{\text{meas}} \cdot \varepsilon_{G,\text{std}})^2 + (I_{\text{range}} \cdot \varepsilon_{L,\text{std}})^2 + (I_{OS,\text{std}})^2}$$

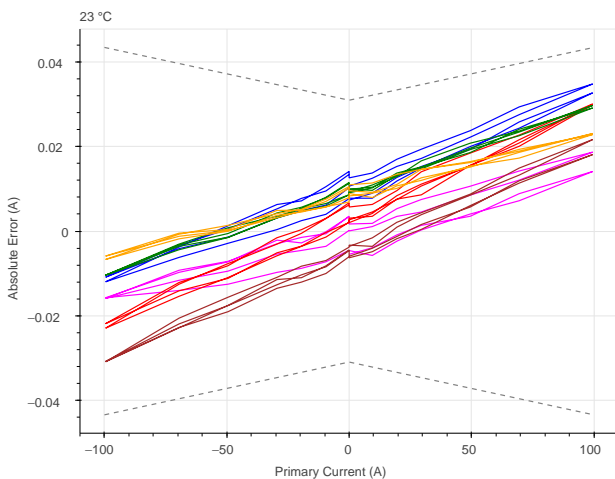

Figure 1: Typical Accuracy at $I_p = \pm 100$ A

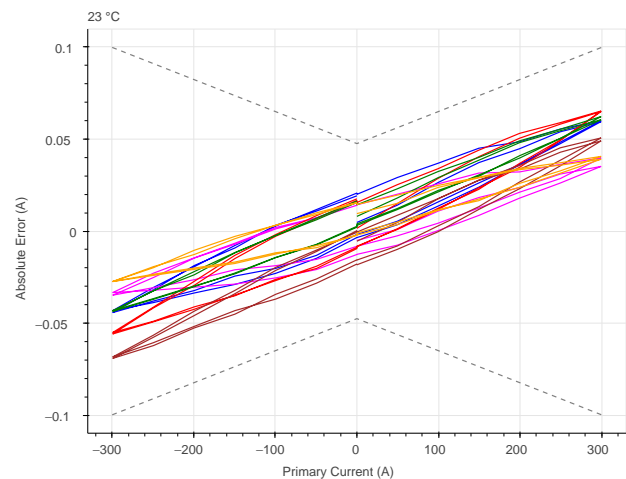

Figure 2: Typical Accuracy at $I_p = \pm 300$ A

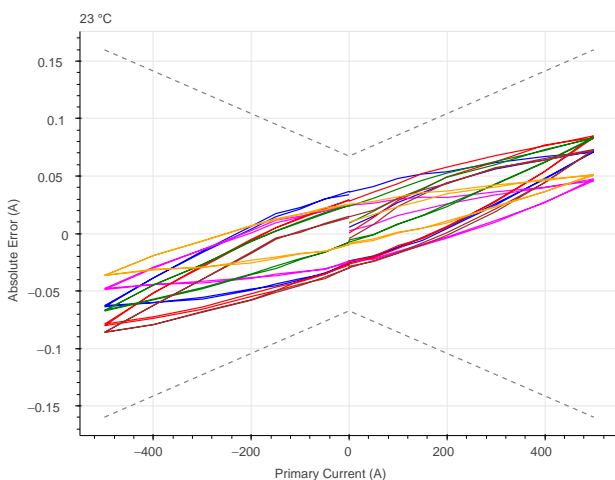

Figure 3: Typical Accuracy at $I_p = \pm 500$ A

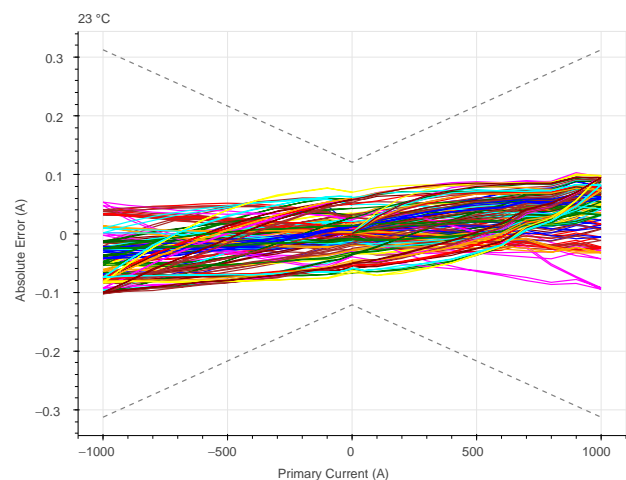

Figure 4: Typical Accuracy at $I_p = \pm 1000$ A

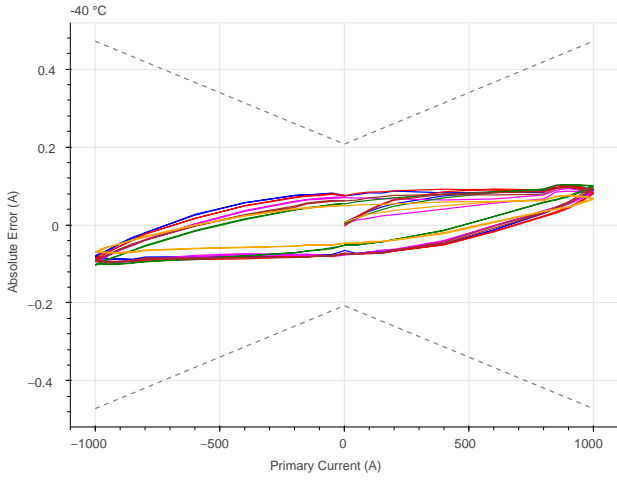

Figure 5: Typical Accuracy at $I_p = \pm 1000$ A

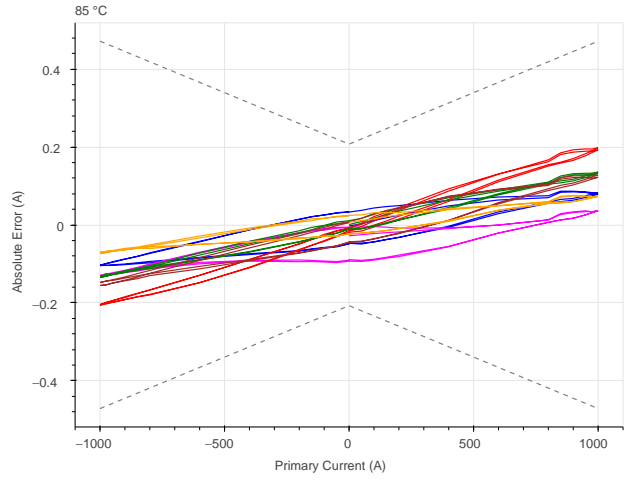

Figure 6: Typical Accuracy at $I_p = \pm 1000$ A

The following figures represent non-linearity vs. selected measurement range I_{range} .

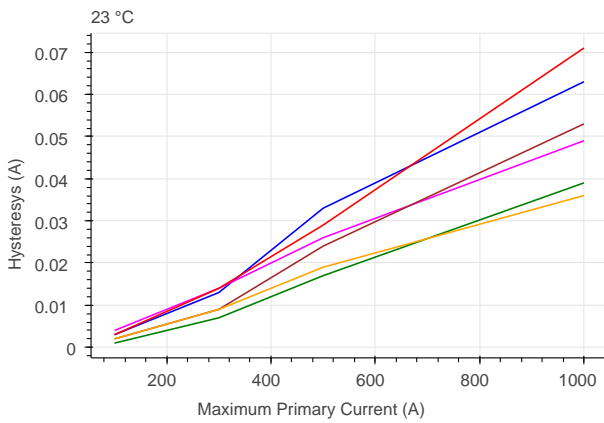

Figure 7: Non-Linearity Referred to Full Scale $I_p = 1000$ A

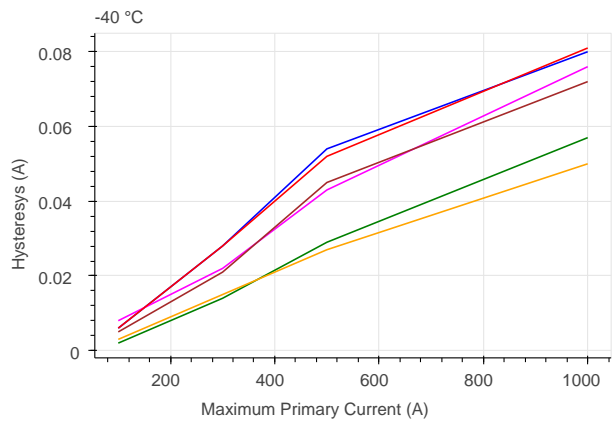

Figure 8: Non-Linearity Referred to Full Scale $I_p = 1000$ A

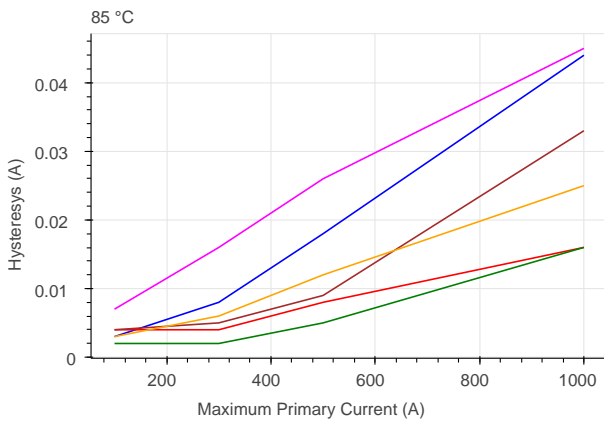

Figure 9: Non-Linearity Referred to Full Scale $I_p = 1000$ A

1.1.2 AC Response

Figure 10 depicts the typical small-signal response at $0.7 A_{RMS}$, and Figure 11 shows the large-signal response up to 150 Hz.

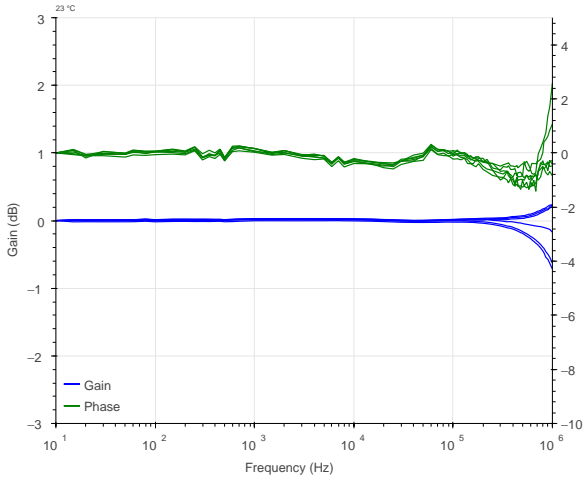

Figure 10: Small Signal AC Response at $I_P \approx 0.7 A_{RMS}$

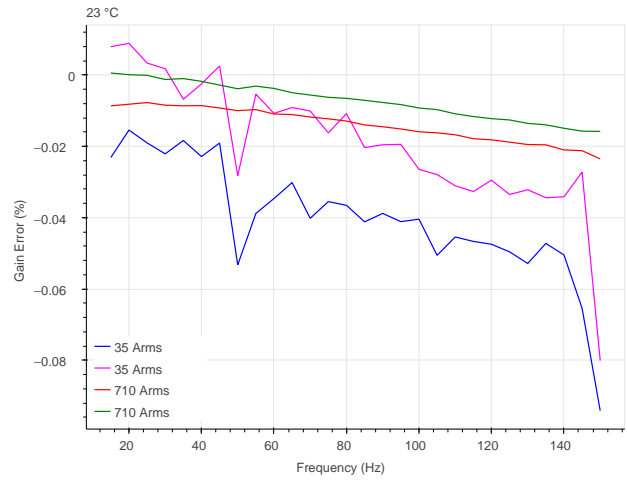

Figure 11: Large Signal AC Response

1.2 Temperature Drift and Stability

The following tests were performed in a temperature chamber (MKFT 115) at a nominal power supply of ± 15 V, using a burden resistor of 2.5Ω , a 5 m cable between the DC-CT and the burden resistor, Keithley DMM7510 and Keysight 34465A digital multimeters, a Danisense DR5000IM reference current sensor, and a primary conductor consisting of a 20 mm diameter round bar in the central position.

1.2.1 Offset Drifting

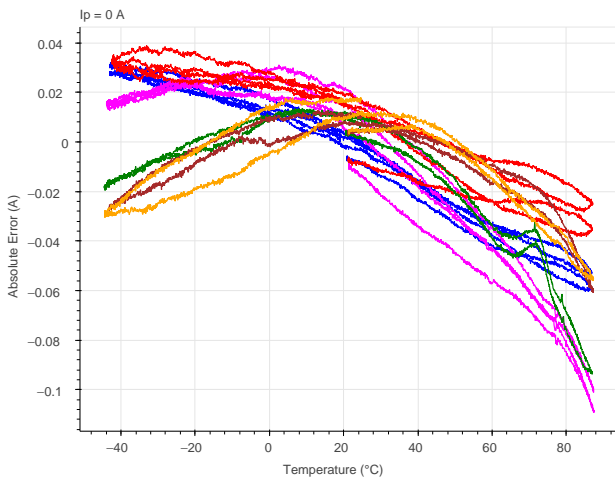

Figure 12: Temperature Drift at $I_p = 0$ A

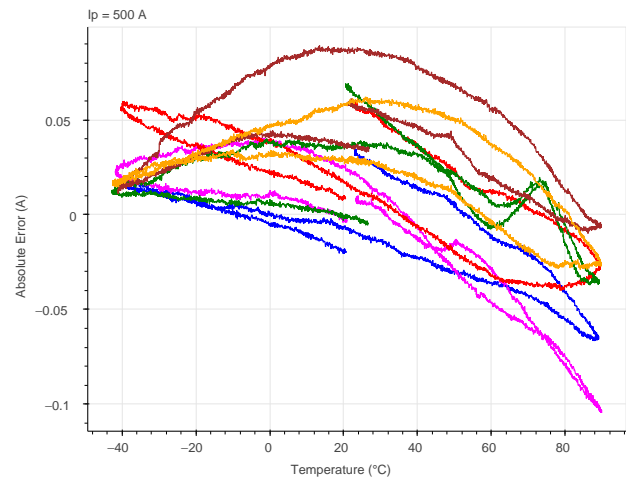

Figure 13: Temperature Drift at $I_p = 500$ A

1.2.2 Time Stability

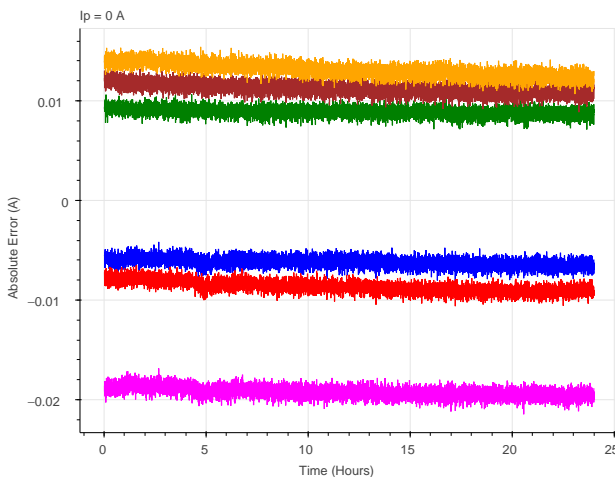

Figure 14: Stability Over 24 Hours at $I_p = 0$ A

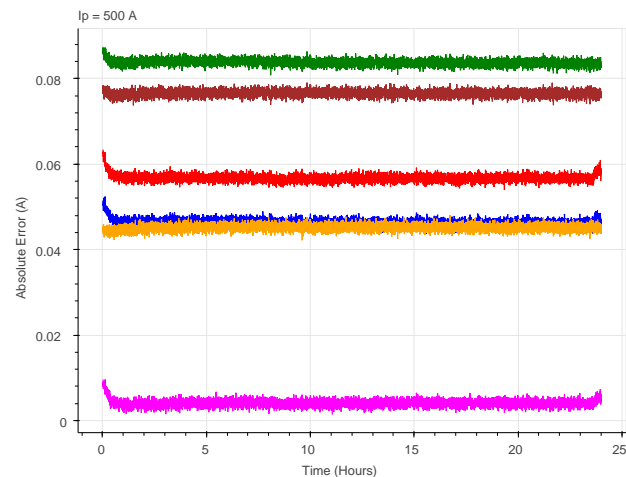

Figure 15: Stability Over 24 Hours at $I_p = 500$ A

1.3 Noise

Noise was evaluated using the INA849 amplifier with a gain of 501, a 2.5 Ω burden resistor, an R&S RTO1004 oscilloscope, and a primary current I_P of 0 A.

1.3.1 100 kHz Bandwidth Noise

These charts show the worst-case noise from three samples at different temperatures for 10 kHz and 100 kHz bandwidths.

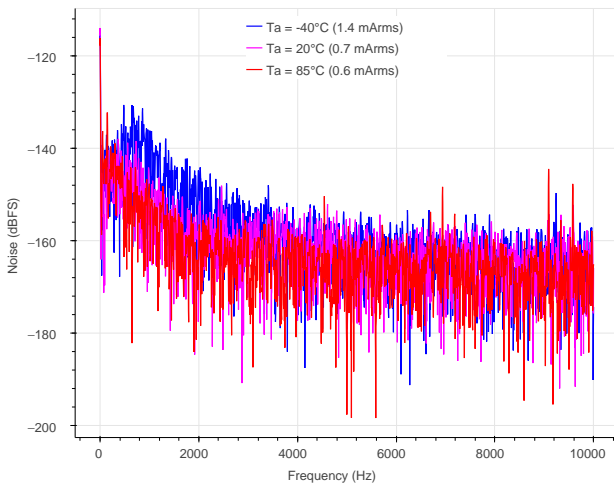

Figure 16: Noise spectrum vs T_A up to 10 kHz

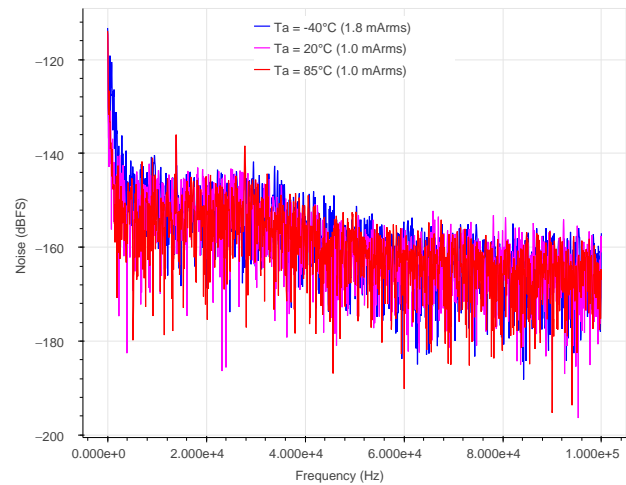

Figure 17: Noise spectrum vs T_A up to 100 kHz

1.3.2 1 MHz Bandwidth Noise and Ripple

Since most of the noise and ripple lie in the upper band above 200 kHz, the first chart shows the worst-case spectrum at different temperatures over a 1 MHz bandwidth. The following three charts show the averaged spectra at different temperatures to clearly display the ripple from various internal switching sources.

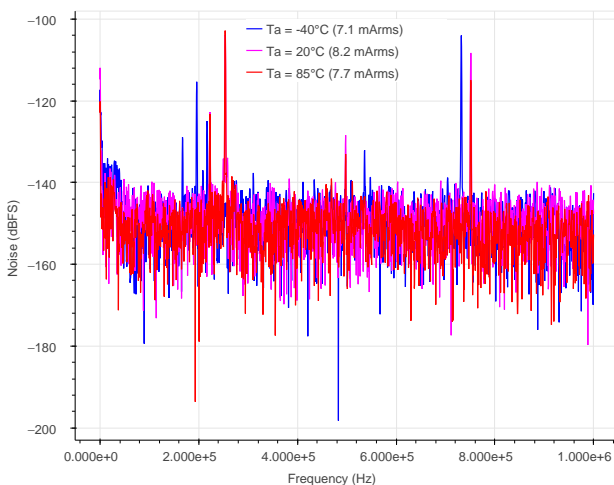

Figure 18: Noise spectrum vs T_A up to 1 MHz

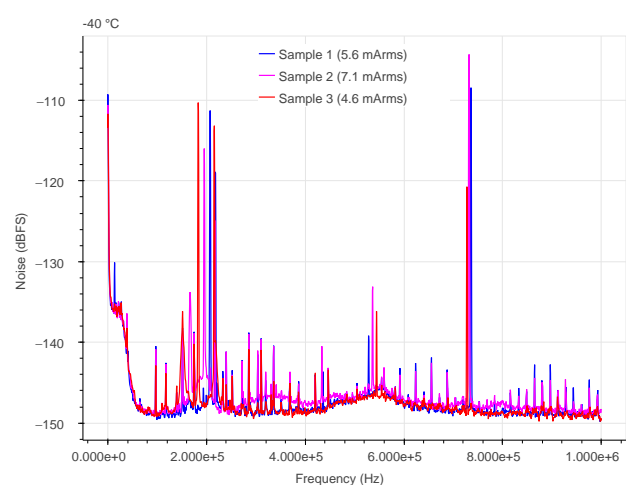

Figure 19: Averaged noise spectrum at $T_A = -40\text{ °C}$

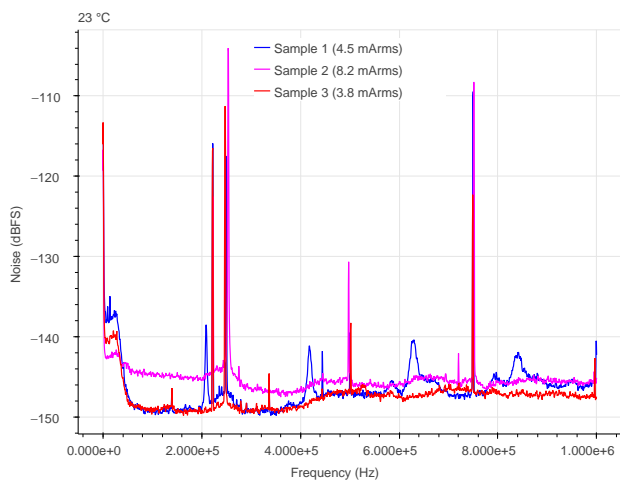

Figure 20: Averaged noise spectrum at $T_A = 23\text{ °C}$

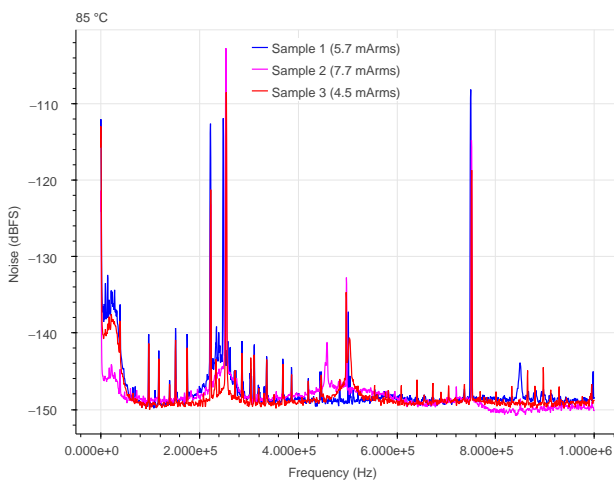

Figure 21: Averaged noise spectrum at $T_A = 85\text{ °C}$

2 Connection and Operation of the Transducer

Figure 22 presents a block diagram of the DC-CT-1000I.

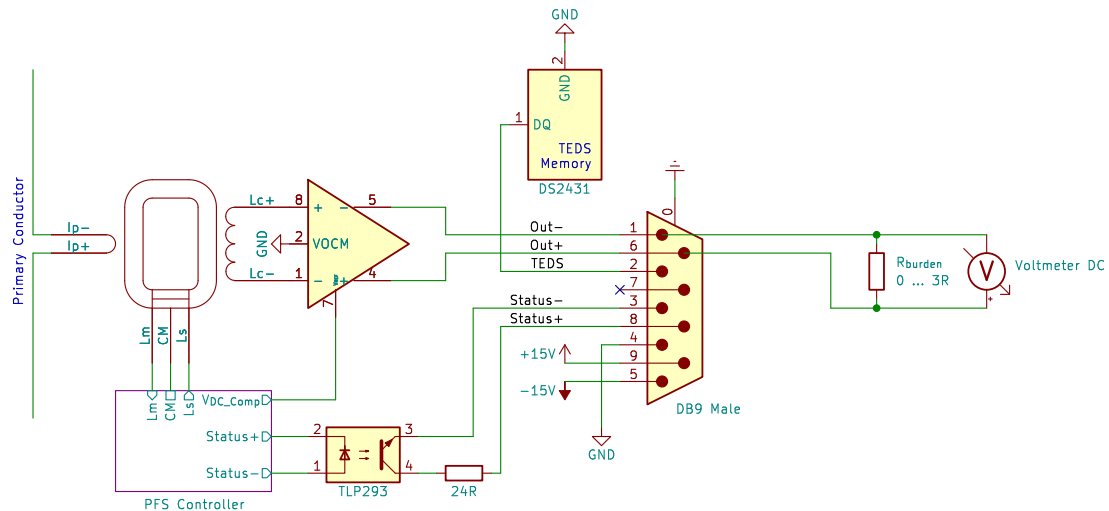

Figure 22: Maximum Burden Resistance vs T_A

It consists of the following key components:

1. Magnetic core with an opening for a primary conductor, with built-in
2. Platiše Flux Sensor, an innovative low-power sensitive residual flux metre that measures the absolute value of the magnetic flux inside the core, reports the valid Status, and drives
3. active compensation via secondary compensation winding, which transforms high bandwidth AC signals and compensates the DC component with the help of the Platiše Sensor. The burden resistor must be provided by the user.
4. Flexible unipolar/bipolar power supply with a floating measurement ground, the output common mode potential,
5. and the TEDS.

2.1 Powering the Unit

The power supply can be either:

1. bipolar: pin 9 (15 V), pin 5 (-15 V) and pin 4 (0 V) or
2. unipolar: pin 9 (30 V) and pin 5 (0 V)

For the best CMRR performance, the units should be earthed via the screw on the bottom or the back-plate. Note that the D-SUB connector is also earthed, but it may create a ground loop with the chassis. It is therefore important to ensure that if the chassis is earthed, the cable of the D-SUB connector is not earthed.

The maximum in-rush current is internally limited to below 0.5 A, as shown in Figure 21.

2.2 Differential Current Output and Status Signal

The DC-CT-1000I provides a differential current output with a common voltage set by pin 4 and scaled down for the number of turns N as the output signal on pins 1 and 6. The user must connect a burden resistor with a maximum resistance vs temperature as provided in Figure 23.

As the unit is powered up, the sequence includes the ramping up of power supplies, the microprocessor boot sequence, followed by the signal search until it is ready. A typical power up sequence takes less than 100 ms. During the power up and signal search, the Status signal is deasserted, as shown in Figure 24; once the signal is valid, the Status is asserted.

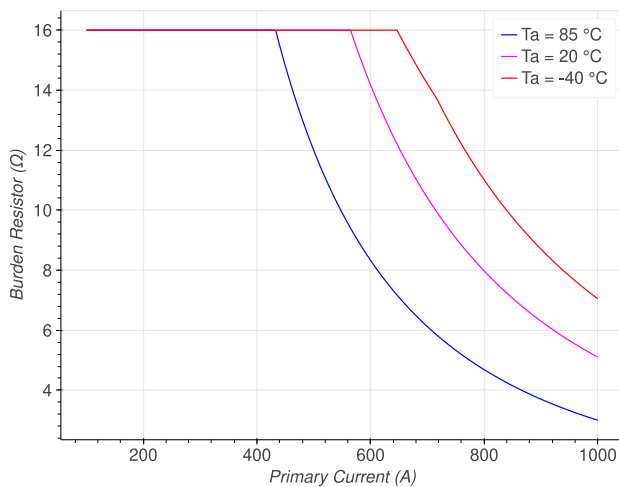

Figure 23: Maximum Burden Resistance vs T_A

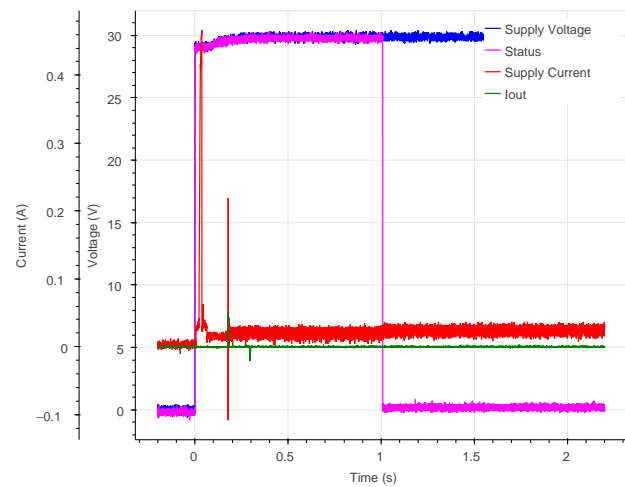

Figure 24: Power-Up Supply, Output Current, Status and Supply Current

Whenever the signal is lost, typically due to being out-of-range and the inability to track the primary signal, the Status signal is deasserted within $300 \mu\text{s}$, and the signal Search procedure begins. As soon as the primary current is successfully tracked within the I_{MD} , the status signal is reasserted.

2.3 About the Innovative Platiše Flux Sensor

For many decades, the most popular DC current transducers have relied on flux-gate or Hall principles. The former, flux-gate, requires a complex three-core structure to achieve the highest accuracy so far down to a few ppm and good AC flatness, while the Hall-based ones hardly reach 0.5% accuracy and have limited frequency bandwidth. Some lower-cost, single chip versions of flux-gate and giant magnetoresistance (GMR) sensors do exist; however, both need to cut the magnetic core to measure the flux.

The Platiše Flux Sensor uses a single core, like the Hall one, and single-chip flux-gate and GMR implementations, but without the air-gap, enabling it to perform nearly as well as the most accurate flux-gate sensors. Due to the simplified construction of the magnetic core, the overall solution is small and thus represents the highest accuracy at the lowest form factor. The Platiše Sensor therefore provides a solution for a wide range of applications requiring accuracies from 0.01% to 0.1%.

The patented measurement principle, as invented by Uroš Platiše, relies on an embedded element inside a magnetic circuit, patented as Current Controlled Variable Reluctance, which effectively redirects magnetic flux within the magnetic core. Being able to redirect fluxes, the constant (DC) flux is easily converted into

a measurable AC signal, at a rate defined by the Platiše Flux Sensor frequency. Since the built-in element inside the magnetic core is not merely passive, but becomes active with external stimuli, the Platiše Sensor is temperature independent. The temperature variations are purely a result of the magnetic material itself and improve with time as the magnetic material enhances.

In addition, the DC-CT-1000I implements a zero-flux or null method to achieve the highest accuracy and compensates for the non-linearities caused by the magnetic material in a similar way to other closed-loop DC-CT sensors. The key blocks are presented in the following Figure.

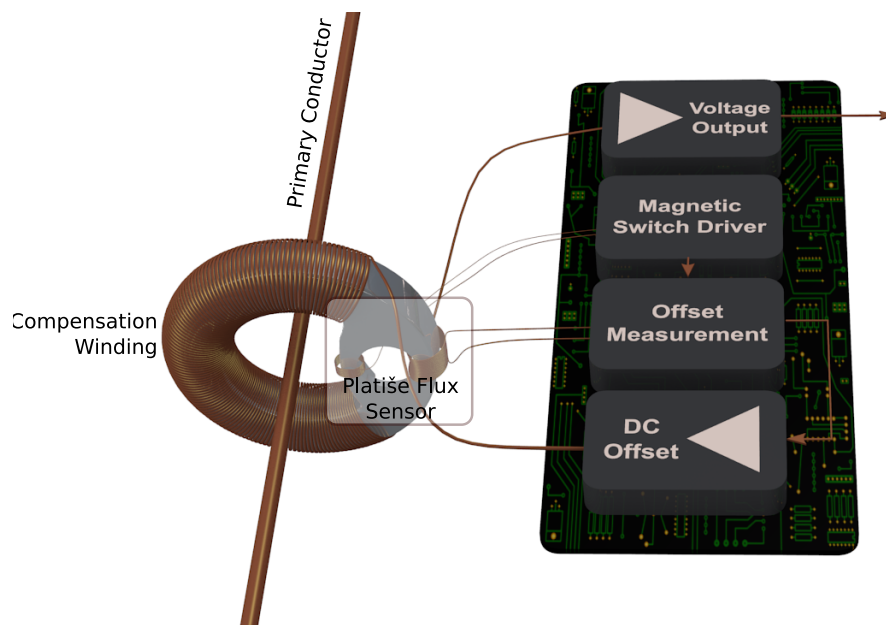

The primary current flows through the magnetic core wound by a secondary compensating winding of N turns, defining a current transformation ratio. An additional modulating winding is added to a small part of the magnetic core, driven by a magnetic switch driver and a sensing winding, which is sensed by offset measurement circuitry. The residual flux is integrated by the output amplifier to compensate for the DC component, while the AC component of the DC-CT passes directly through the sensor to the output.

More information about the technology can be found at www.dc-ct.com.

DC-CTs that use this new patented principle of operation are branded under the DC-CT[®] and DOT[®] brands.

3 Dimensions

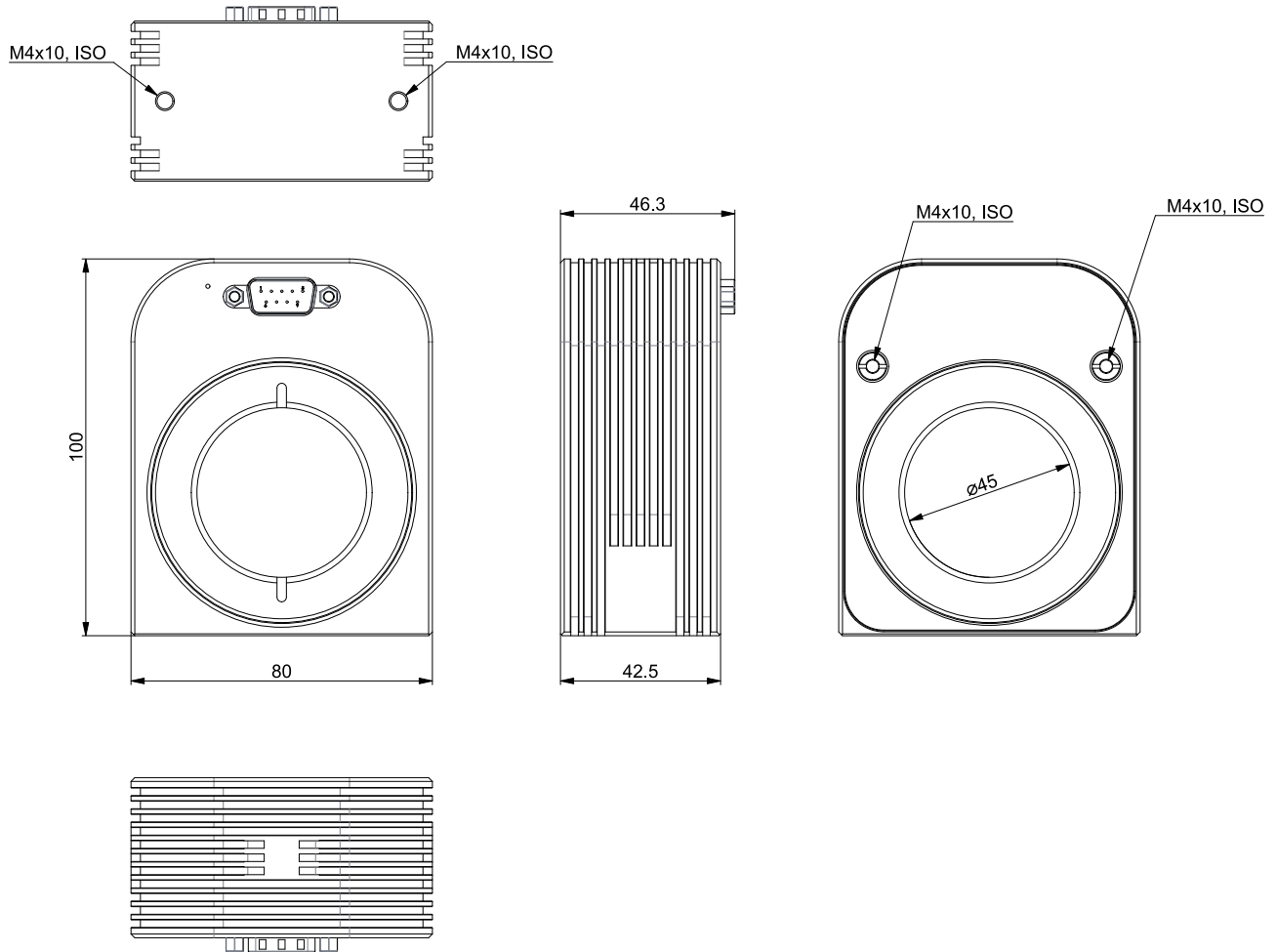

4 Ordering Information

Ordering Code	Description
DC-CT-1000I-S45DA	1000 A, Stand-alone, 45 mm Opening, D-SUB, Analogue Current Output

Disclaimer

DOT[®] and DC-CT[®] are registered trademarks of ISOTELpower Ltd, Slovenia. The information contained herein is the copyright of ISOTELpower Ltd, Slovenia, hereafter referred to only as ISOTEL. ISOTEL makes no representations or warranties with respect to the accuracy or completeness of the contents of this document and reserves the right to make changes to product descriptions at any time without notice. ISOTEL does not make any commitment to update the information contained herein unless specifically provided otherwise.